

**IBARMIA.**

# T MULTIPROCESS

36 / 30 / 22 / 16 / 12

## 5 AXIS UNIVERSAL MULTITASKING MACHINING CENTERS

Universal machining centers for 5 axis machining of big diameter parts focused on high productivity by integrating multitasking technology and automation systems.



**T SERIES**

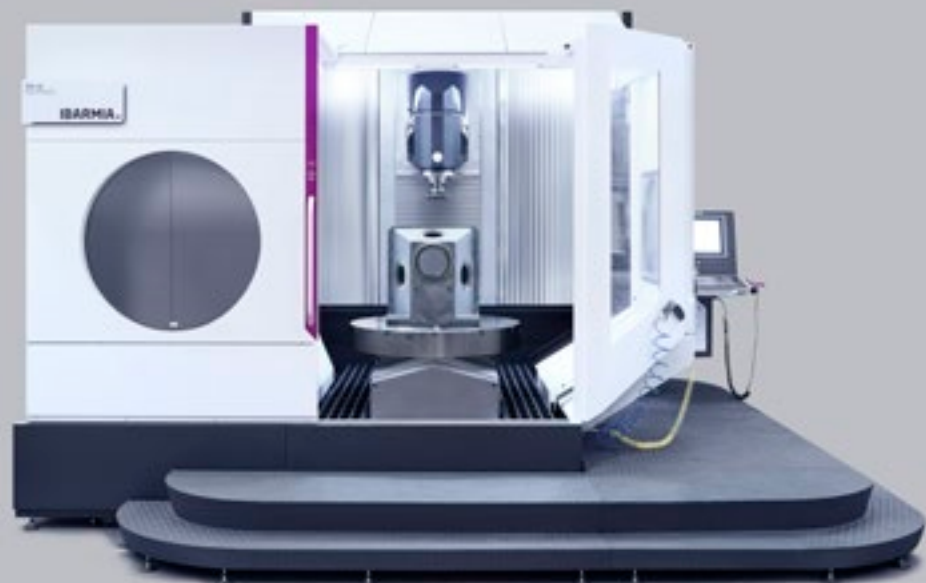

[www.ibarmia.com](http://www.ibarmia.com)

## T MULTIPROCESS



MANUFACTURING TECHNOLOGY

## HIGH PRODUCTIVITY ADVANCED MACHINING

The IBARMIA T SERIES is designed for high productivity in 5 axis machining of heavy pieces thanks to its high load capacity rotary tables and powerful spindles. Its award-winning tilting heads (two models in option) provide the speed, accuracy and reliability required for the most complex jobs. The possibility to adapt the size of each model to specific parts or to provide the most advanced automation solutions for automatic pallet changing and special head changing operations, make IBARMIA T SERIES the ideal solution for the most demanding production requirements.

The T MULTIPROCESS models integrate milling and turning capacity reducing the number of machines required to produce a wide range of pieces.

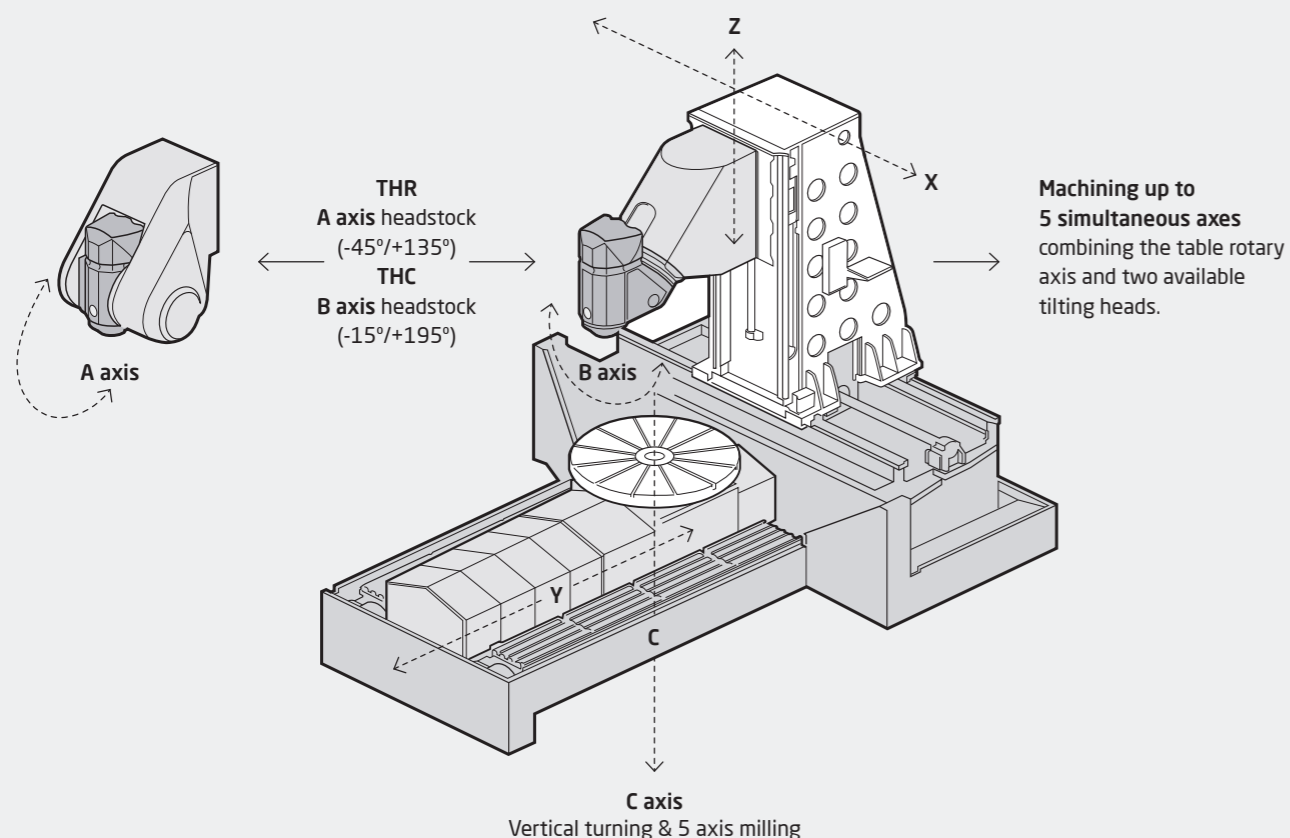

## T SERIES\_ BODY SIZES

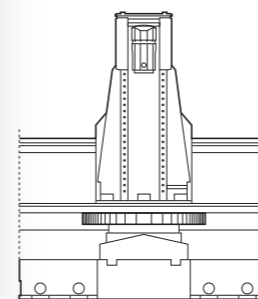

T36

Maximum swing diameter  
ø 3600 mm  
Maximum part height  
h 2150 mm  
Maximum load capacity  
22.500 Kg\*  
(\*Multiprocess)

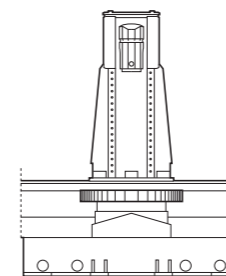

T30

Maximum swing diameter  
ø 3000 mm  
Maximum part height  
h 1950 mm  
Maximum load capacity  
20.000 Kg

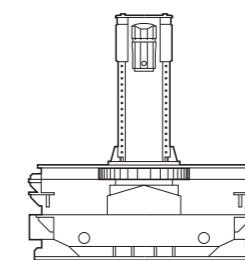

T22

Maximum swing diameter  
ø 2200 mm  
Maximum part height  
h 1750 mm  
Maximum load capacity  
10.000 Kg

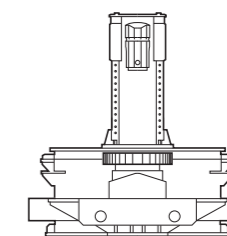

T16

Maximum swing diameter  
ø 1600 mm  
Maximum part height  
h 1700 mm  
Maximum load capacity  
6000 Kg

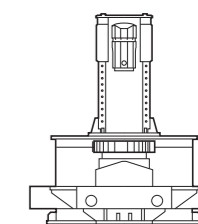

T12

Maximum swing diameter  
ø 1250 mm  
Maximum part height  
h 1600 mm  
Maximum load capacity  
4500 Kg\*  
(\*Multiprocess)

## T SERIES\_ SPINDLE HEADS



**THC\_ B axis head**  
Maintain the same tool center point  
across the full range  
-15°/+195°



**THR\_ A axis head**  
Fork type spindle head ideal for  
negative angles  
-45°/+135°



**Two Options Available**  
Standard: Dynamics and high  
revolutions; Optional: high torque  
for the hardest materials.

Tool holders (Multiprocess)  
HSK 100 / CAPTO C8  
Total available power from  
Standard: 4000 rpm  
Option: 700 rpm  
Power in S1 (100%); S6 (40%)  
Standard: 74 kW / 84 kW  
Option: 52 kW / 73 kW  
Toque in S1 (100%); S6 (40%)  
Standard: 300 Nm / 452 Nm  
Option: 500 Nm / 700 Nm  
Maximal rotation speed  
Standard: 12.000 rpm  
Option: 7000 rpm

## T SERIES\_ SINGLE PALLET MACHINES

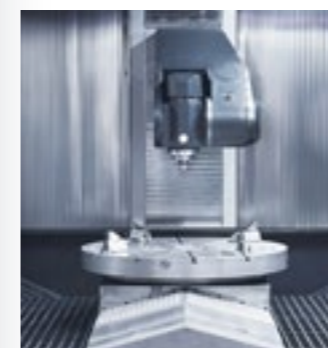

All the T models are available with fixed table, for those customers looking for the advanced manufacturing of big swing diameter parts in only one set up.

## T SERIES\_ MULTIPALLET MACHINES

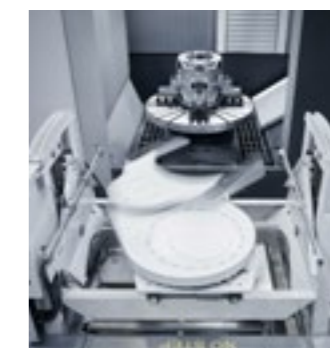

On the other hand, IBARMIA offers different degrees of automatic pallet changers that allow a perfect adaptation of the specific production requirements in each case.

- 01\_
  - Thermo-symmetrical and thermostable structure design.
  - Monoblock design of the machine bed designed to optimize the evacuation of chips. Maximum stability and rigidity ensured by the well proportioned distances between guides.
- 02\_
  - Finite Elements optimization of the maximum rigidity structural bodies.
  - Movement on X / Y / Z axis over linear guides with preloaded rolling shoes with two rows of circulating rollers.
- Rectified ball screws of high precision with preloaded double nuts for the longitudinal axis movement.
- Direct measuring on linear X, Y, Z axes: glass scales.
- 03\_
  - Measuring by rotary scale on rotary axes. Geometric check and volumetric calibration on request.
- 04\_
  - Endless screws system on both sides of the working table for an optimum evacuation of chips (double screw in T36 / T30; optional in T22 / T16).

**T SERIES\_ CONSTRUCTION FEATURES**

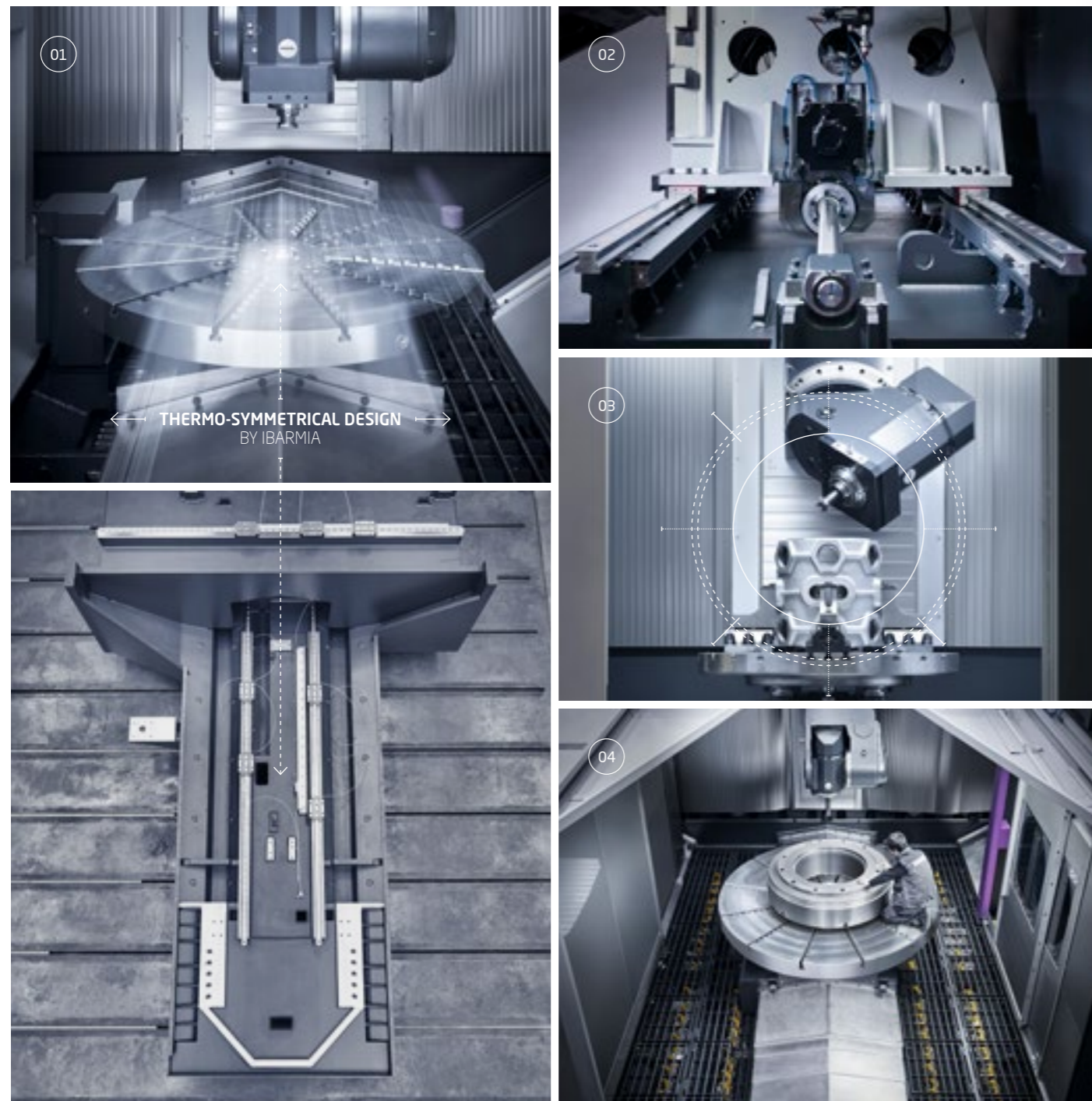

**T SERIES\_ STANDARD CHARACTERISTICS**

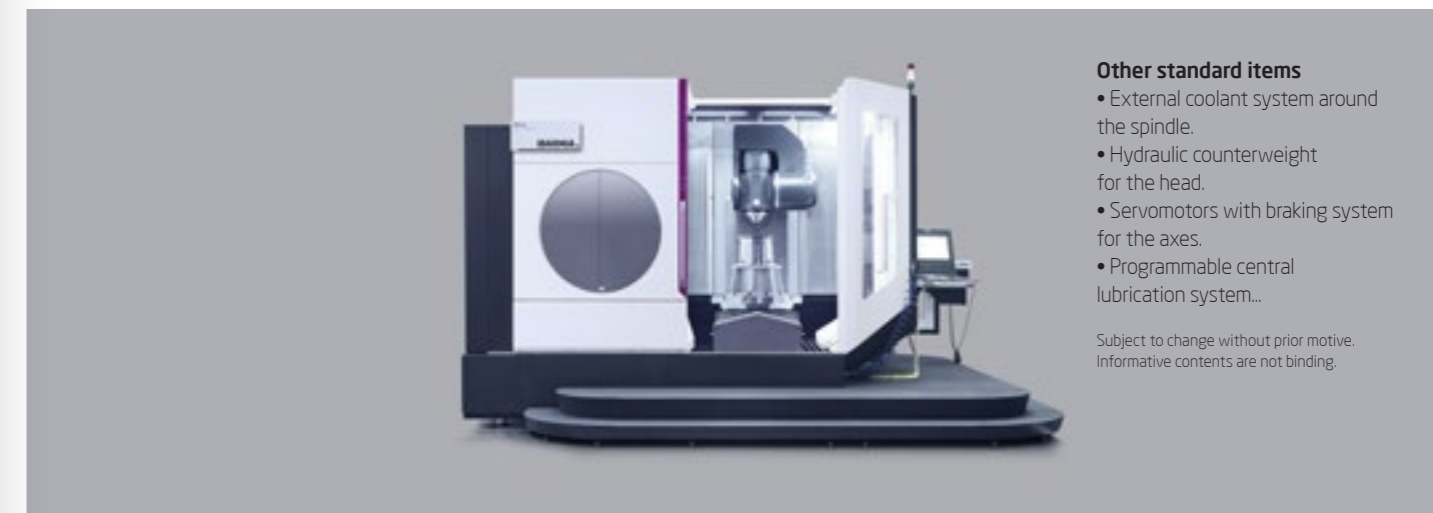
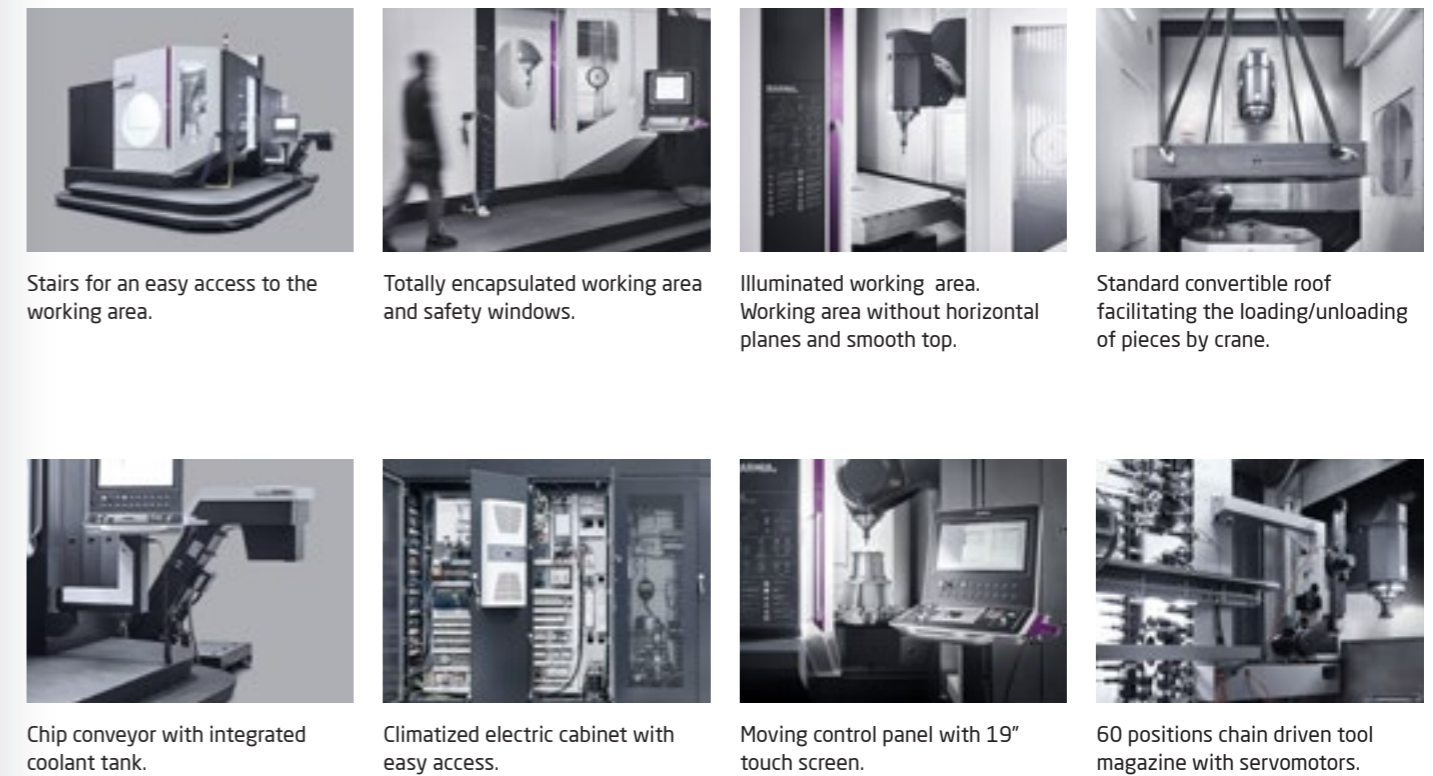



UNIVERSAL MACHINING CENTERS

T MODELS\_ MAIN CONFIGURATION OPTIONS



**Tool management:** 120-240-360 positions chain driven tool magazine with servomotors.



**Tool management:** Pick-ups for special tools (heavier and/or longer tools).



**Tool management:** S.A.S stations for agile manual feeding of tools to the magazine.



**Tool management:** Rack type robotized magazines available.

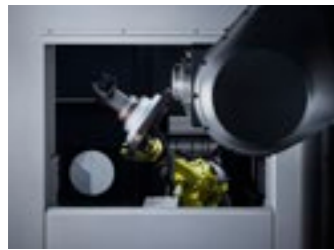

**Tool management:** Random system tool magazines managed by robot arm to combine tool and head change.



**Working table management:** Manual fast pallet changin system. For automatic pallet changing solutions, see below.

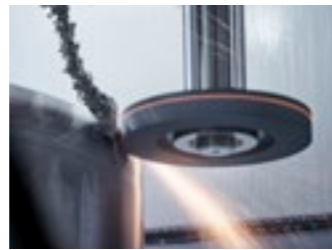

Grinding capability with different cycles depending on the machine model (Multiprocess / Extreme).

**Other optional items**

- Coolant through spindle.
- Tool measuring and touch systems.
- Steam and mist aspiration system.
- "Illumination" pack: LED lights with acoustic signal indicating the state of the machine, integrated into the machine.
- Lights with acoustic signal indicating the machine status.
- Camera settings and display mode.
- Control with touch screen up to 24"

T MODELS\_ OPTIONAL MULTIPALLET SOLUTIONS

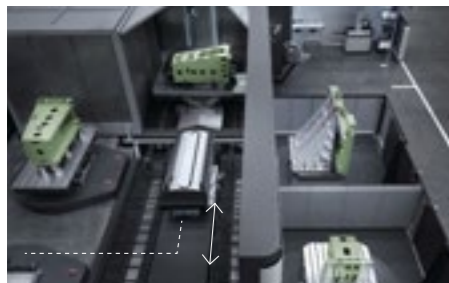

**1\_ PALLET POOLS** For T36 / T30 / T22 models  
IBARMIA manufactures customized modular solutions with 2 to 4 stations that can be extended in the future.

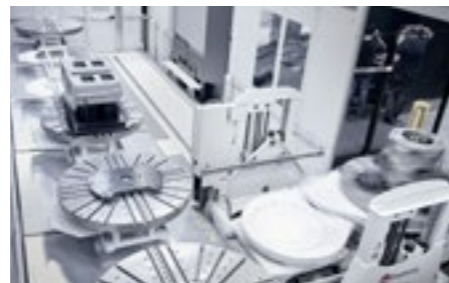

**2\_ PALLET POOLS** For T16 / T12 models  
Facilities integrating a flexible pallet warehouse in combination with one or more T16 or T12 machining centers.



**3\_ ROTOPALLET** for T16 / T12 models  
A rotary double fork device on the frontside of the machine makes a quick change of two pallets.



MANUFACTURING TECHNOLOGY

T MULTIPROCESS



**Multitasking concept**

The Multiprocess technology combines the following processes in one machine: turning, milling, drilling, grinding, tapping, advanced gear machining (skiving-hobbing), boring. The CNC includes specific functions to support every process and optimize the performance of the machine.

**High productivity concept**

Combine random system large tool magazines with robots arms for a quick changing of heavy heads up to 100 kg and extra long tools for deep internal diameter turning operations.

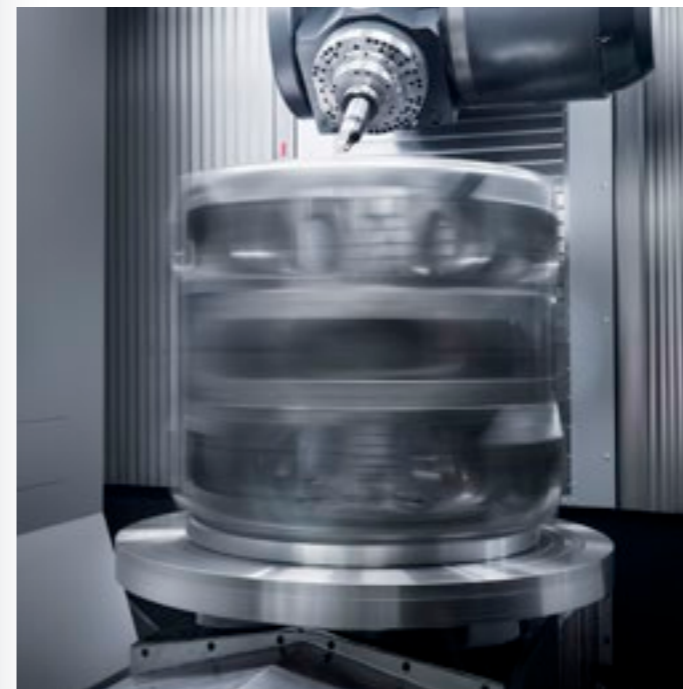

**C axis vertical turning tables**

Multitasking capacity thanks to high dynamics and accurate positioning tables for turning and milling advanced operations.

- Table ø from 1000 to 2000 mm.
- Max load for turning operations from 2250 to 16.000 kg.
- Torque motor transmission.
- Max speed from 150 to 500 rpm.
- Power in S1 from 50 to 115 kW.
- Torque in S1 from 1850 to 12.000 Nm.
- Positioning accuracy +/-4".

**IBARMIA ECO DESIGN**

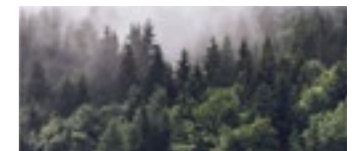

Machines designed considering the environmental impact during all their useful life cycle.



T MULTIPROCESS

POWER & CAPACITY IN HIGH PRODUCTIVITY TURNING AND MILLING CENTERS

Integrate vertical turning capacity into this 5 axis universal machining center, combining high dynamics tilting heads with the wide range turning plates available.

**1\_B** - A axis continuous milling heads with torque motor. Direct measuring by encoder installed on the rotary axis. Up to 84 kW / 12.000 rpm.

**2\_C** axis turning & milling. Parts up to  $\varnothing 3600$  mm and 2150 mm height. Up to 22.500 kg (milling) and 500 rpm.

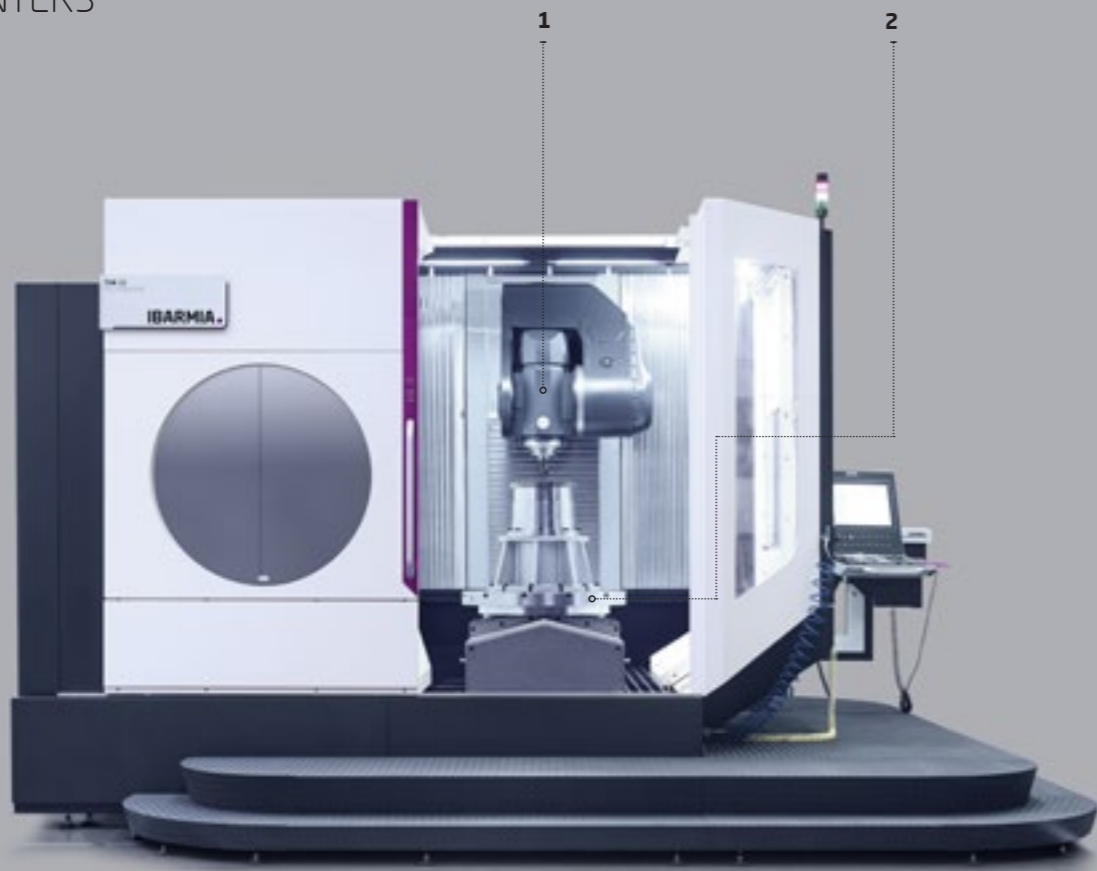

IBARMIA can provide two types of spindle heads to adapt the machine to specific jobs. A wide range of options allows tailoring solutions to each requirement.



**THC\_B axis head**  
Maintain the same tool center point across the full range  $-15^{\circ}/+195^{\circ}$



**THR\_A axis head**  
Fork type spindle head ideal for negative angles  $-45^{\circ}/+135^{\circ}$

T MULTIPROCESS



UNIVERSAL MACHINING CENTERS

T MULTIPROCESS\_ SAMPLE APPLICATIONS



Compressor Cylinder



Valve body



Double helical gear



Railway wheel



Engine compressor housing



Machinery component



Ram Bop



Impeller shaft



Pipe line compressor housing



MACHINERY



OIL & GAS



RAILWAY



AEROSPACE



AUTOMOTIVE

**T SERIES**  
ELECTROSPINDLES AVAILABLE\*

**DIGITAL TECHNOLOGY SPINDLES**

**1\_ STANDARD**

**Power and dynamics\_**

Up to 12.000 rpm.  
74/84 kW (S1/S6)  
300/452 Nm (S1/S6)

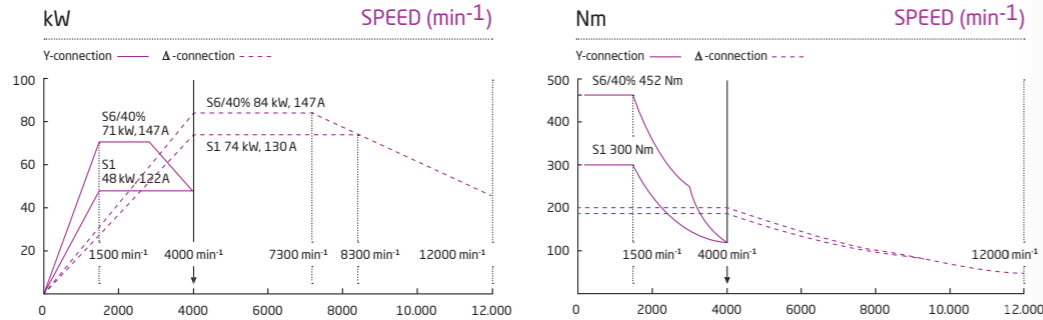

**2\_ OPTIONAL**

**High torque for the hardest materials\_**

Up to 7000 rpm.  
52/73 kW (S1/S6)  
500/700 Nm (S1/S6)

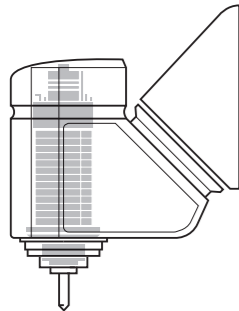
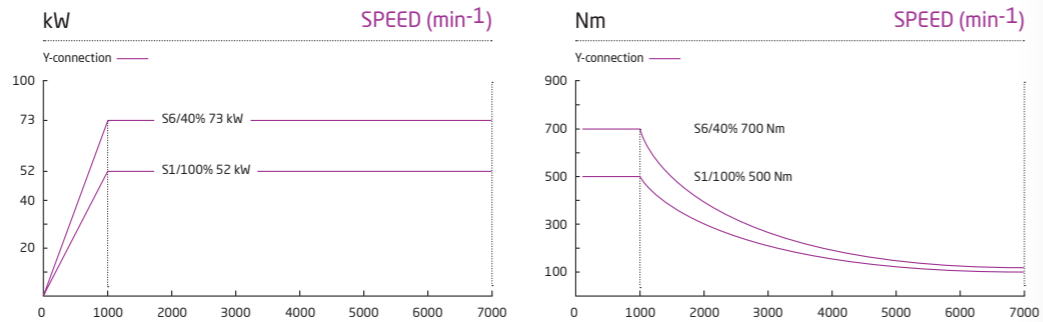

THC\_ B axis head

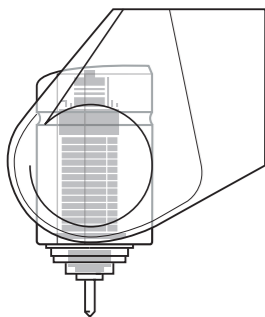

THR\_ A axis head



\*More spindles on request

**T MULTIPROCESS**  
TECHNICAL DATA

**TRAVELS**

- X axis travel (length)
- Y axis travel (cross)
- Z axis travel (vertical)
- B - A axis heads tilting range
- Maximum swing diameter
- Piece maximum height
- Distance spindle nose-table. Vertical (B axis)
- Distance spindle nose-table. Horizontal (B axis)
- Distance spindle nose-table. Vertical (A axis)
- Distance spindle nose-table. Horizontal (A axis)

	T 36	T 30	T 22	T 16	T 12
-X axis travel (length)	3600 mm	3000 mm	2200 mm	1600 mm	1200 mm
-Y axis travel (cross)	2300 mm	2000 mm	1600 mm	1600 mm	1300 mm
-Z axis travel (vertical)	1900 mm	1700 mm	1500 mm	1200 mm	1000 mm
-B - A axis heads tilting range	B: -15° / +195° - A: -45° / +135°				
-Maximum swing diameter	3600 mm	3000 mm	2200 mm	1600 mm	1250 mm
-Piece maximum height	2150 mm	1950 mm	1750 mm	1700 mm	1600 mm
-Distance spindle nose-table. Vertical (B axis)	100 / 2000 mm	100 / 1800 mm	100 / 1800 mm	100 / 1300 mm	100 / 1100 mm
-Distance spindle nose-table. Horizontal (B axis)	100 / 2000 mm	100 / 1800 mm	100 / 1800 mm	100 / 1300 mm	100 / 1100 mm
-Distance spindle nose-table. Vertical (A axis)	-115 / 1785 mm	-115 / 1585 mm	-115 / 1385 mm	-115 / 1085 mm	-115 / 885 mm
-Distance spindle nose-table. Horizontal (A axis)	260 / 2160 mm	260 / 1960 mm	260 / 1760 mm	260 / 1460 mm	260 / 1265 mm

**TABLE\***

- Table dimensions
- Maximum table load capacity (\*turning)
- Nominal speed
- Maximum speed
- Nominal torque

\*More table options on request

Table dimensions	ø 2000 mm	ø 1800 mm	ø 1600 mm	ø 1200 mm	ø 1000 mm
-Maximum table load capacity (*turning)	22.500 - *16.000 kg	20.000 - *14.000 kg	10.000 - *6000 kg	6000 - *3000 kg	4500 - *2250 kg
-Nominal speed	90 rpm	88 rpm	189 rpm	258 rpm	300 rpm
-Maximum speed	150 rpm	200 rpm	400 rpm	500 rpm	500 rpm
-Nominal torque	12.000 Nm	10.000 Nm	4000 Nm	3000 Nm	1850 Nm

**TILTING HEAD**

- Turning torque
- Position clamping force

-Turning torque	1210 Nm
-Position clamping force	7000 Nm

**MAIN SPINDLE**

- Tool holder
- Maximum speed
- Maximum power
- Maximum torque

-Tool holder	Standard: HSK A 100 - Option: Capto C8
-Maximum speed	Standard: 12.000 rpm - Option: 7000 rpm
-Maximum power	Standard: 84 kW - Option: 75 kW
-Maximum torque	Standard: 452 Nm - Option: 871 Nm

**FEED**

- Maximum working feed X-Y-Z axes
- Rapid feed for positioning X-Z axes
- Rapid feed for positioning Y axis
- X-Y-Z axes acceleration
- Rapid feed for positioning in B-A axes

-Maximum working feed X-Y-Z axes	30 m/min	50 m/min	60 m/min
-Rapid feed for positioning X-Z axes	40 m/min	50 m/min	60 m/min
-Rapid feed for positioning Y axis	30 m/min	50 m/min	60 m/min
-X-Y-Z axes acceleration	1,5 / 1,5 / 2 m/s <sup>2</sup>	1,7 / 1,8 / 2,2 m/s <sup>2</sup>	2 / 2,1 / 3,3 m/s <sup>2</sup>
-Rapid feed for positioning in B-A axes	50 rpm		

**ACCURACY VDI / DGQ3441**

- Positioning Tp X-Y-Z (1000 mm)\*
- Repeatability
- Measuring system on B - A axes
- Positioning accuracy B - A axes
- Positioning accuracy C axis

\*Under certain conditions

-Positioning Tp X-Y-Z (1000 mm)*	10 µm	7 µm	6 µm
-Repeatability		5 µm	
-Measuring system on B - A axes		Rotary scale	
-Positioning accuracy B - A axes		+/- 5 s	
-Positioning accuracy C axis		+/- 4 s	

**CAPACITIES**

- Milling capacity in steel St 60
- Drilling capacity in steel St 60
- Tapping capacity in steel St 60

-Milling capacity in steel St 60	1100 cm <sup>3</sup> /min
-Drilling capacity in steel St 60	ø 70 mm
-Tapping capacity in steel St 60	M 45 mm

**TOOL MAGAZINE**

- Number of tools
- Maximum tool length
- Maximum tool weight
- Maximum tool diameter with full magazine
- Maximum tool diameter with free spaces
- Tool changing time\*
- Chip to chip time

\*Under certain conditions

-Number of tools	Standard: 60. Option: 120, 240, 360
-Maximum tool length	600 mm
-Maximum tool weight	20 kg
-Maximum tool diameter with full magazine	125 mm
-Maximum tool diameter with free spaces	250 mm
-Tool changing time*	6 s
-Chip to chip time	16 s
	14 s
	12 s
	8 s
	7 s

**CNC CONTROL**

- Available digital controls

-Available digital controls	Fanuc / Heidenhain / Siemens
-----------------------------	------------------------------

# IBARMIA.



## YOUR MACHINE TOOL POINT

Diego Umantsoro, 5 - Apdo 35  
20720 Azkoitia (Gipuzkoa) Spain. T +34 943 857 000  
ibarmia@ibarmia.com



[www.ibarmia.com](http://www.ibarmia.com)